Selection guide page 3/2

Interfaces for discrete signals

- Electromechanical interface modules page 3/4
- Slim electromechanical interface modules page 3/10
- Slim solid-state interface modules page 3/16

Applications **Electromechanical interface modules**



Functions	Input	
Width (mm)	17.5	9.5
Contact arrangement	1 N/O 2 N/O 1 C/O	1 N/O
Thermal current	-	
Control voltages	\equiv 110...127 V \sim 24 V, 48 V \sim 115...127 V \sim 230/240 V	\equiv 24 V, 48 V \sim 115...127/50 Hz \sim 115...127/60 Hz \sim 230...240/50-60 Hz
Indication	Mechanical for contacts and/or LED for control	LED for control
References	ABR-1E	ABR-2E
Pages	3/4	3/10

Solid state interface modules



Output		Input and output Very low level switching	Input	Output
17.5	12	17.5	9.5	9.5/17.5
1 N/O 2 N/O 1 C/O 1 N/C + 1 N/O	1 N/O	1 C/O	-	
12 A	5 A	-		5 A
⎓ 24 V ⎓ 24 V, 48 V ~ 115...127 V ~ 110 V	⎓ 24 V		⎓ 5, 24, 48 V ~ 115...127/50 Hz ~ 120...127/60 Hz ~ 230...240/50 Hz ~ 230...240/60 Hz	⎓ 24 V
Mechanical for contacts and/or LED for control	LED for control			
ABR-1S	ABR-2S	ABR-2●B312B	ABS-2E	ABS-2S
3/4	3/10	3/10	3/16	

Interfaces

For discrete signals

Electromechanical interface modules

ABR-1 electromechanical interface modules are supplied in the form of compact modules, 17.5 mm wide. They are designed for interfacing discrete digital control signals exchanged within an automated system between the processing unit (PLC, numerical controller, etc) and the other components (contactors, solenoid valves, indicator lamps, proximity sensors, etc). These products are based on contactor technology and are notable for their excellent adaptation to industrial environments, ensured by the fact that they conform to the most recent IEC 947-5-1 standards.

Composition

The ABR-1 range comprises 2 families :

Input interfaces

Input interfaces are designed for switching input signals to the processor and are characterized by their high degree of contact reliability : less than 1 fault per 100 million operating cycles at $\bar{\sim}$ 17 V, 5 mA. The switching level is sufficiently high to ensure that the interfaces can directly control most contactors and indicator lamps.

Output interfaces

Output interfaces are designed for the control of preactuators (contactors, solenoid valves, etc) for signalling devices (indicators lamps, audible warnings, etc). They are characterized by a high switching capacity and an average durability 5 times greater than that of traditional interface modules which incorporate standard relays.

- 1 Override contacts by pressing button (not holding it down) for a simple and quick test during setting up or maintenance operations on the installation
- 2 Green indicator showing the mechanical position of the contacts
- 3 LED indicating the control signal state
- 4 Channel identification : 5 individual characters for AB1-R/G or one AB1-SA2 marker tag
- 5 Connection by screw clamp terminal enabling easy attachment of 2 wires per terminal. The layout of the connection terminals for both families (input and output) is designed for rational wiring and a clear separation between the incoming (processing) and outgoing (power and process control) circuits.

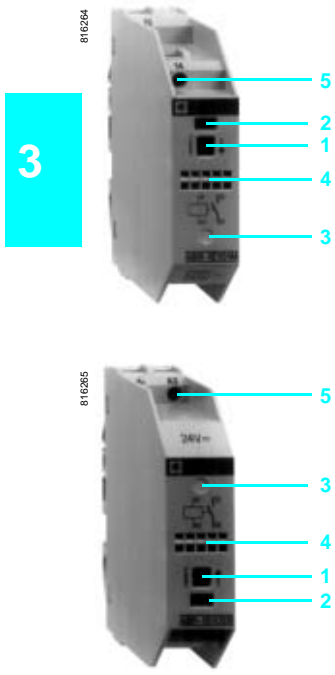

Examples of applications with PLCs

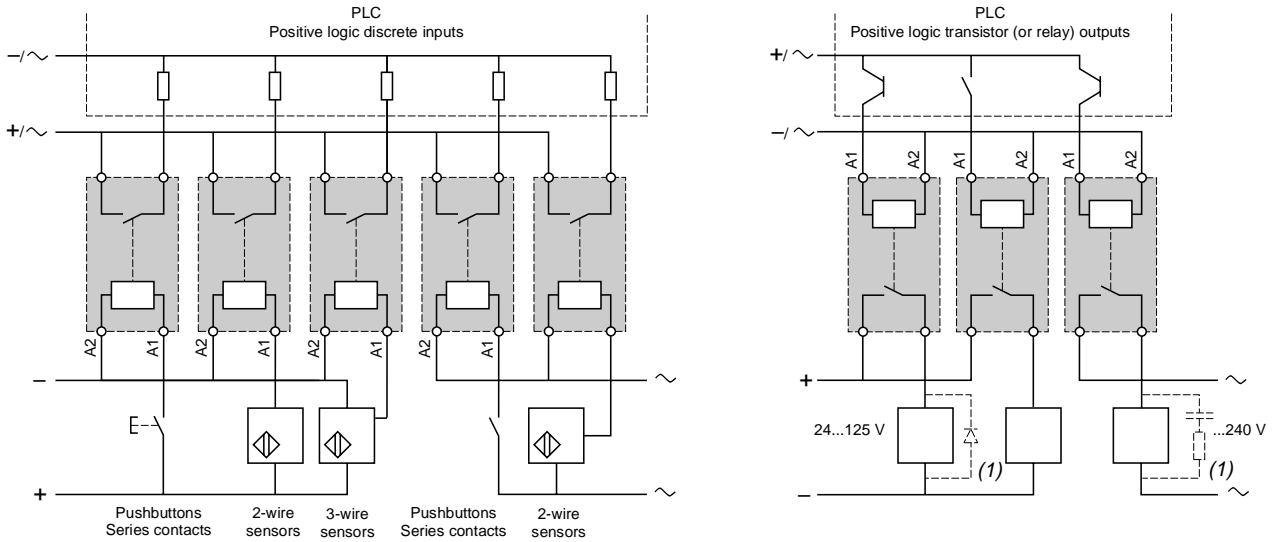

(1) Essential on inductive loads (can be replaced with peak limiter).

Environment

Conforming to standards		IEC 947-5-1	
Product certifications		UL, CSA, BV, LROS, DNV	
Degree of protection	Conforming to IEC 529 (protection against direct contact)	IP 00	
Protective treatment		"TC"	
Flame resistance	Conforming to IEC 695-2-1	Incandescent wire	°C 850
		Conforming to UL 94	V0
Shock resistance	Conforming to IEC 68-2-27	Semi-sinusoidal waves 11 ms	50 gn
Vibration resistance	Conforming to IEC 68-2-6	10...55 Hz	6 gn
Resistance to electrostatic charges	Conforming to IEC 801-2	Level 3	kV 8
Resistance to rapid transients	Conforming to IEC 801-4	On power supply	kV 2
		On I/O	kV 1
Resistance to shock waves	Conforming to IEC 255-4	Waveform	kV 0.5
		1.2/50 ms ; 0.5 J	kV 2.5
Cross-sections which may be connected	Flexible cable with no cable end	1 or 2-wire	mm ² 0.6...2.5
	Flexible cable with cable end	1 or 2-wire	mm ² 0.34...2.5
	Rigid cable	1-wire	mm ² 0.27...4
		2-wire	mm ² 0.27...2.5
Operating position		Any	
Ambient air temperature around the device	Unrestricted operation	°C - 5...+ 40	
	Permissible at Un	°C - 20...+ 60	
	Storage	°C - 40...+ 70	
Operating altitude		m ≤ 3000	
Installation category	Conforming to IEC 947-1	II	
Degree of pollution	Conforming to IEC 947-5-1	3	
Mounting		Standard rails	

Control circuit characteristics (40°C ambient temperature)

Type of interface		ABR 1S02B	ABR 10008B	ABR 10008E	ABR 1E012F	ABR 10001F	ABR 1E011M	ABR 1E001M
Rated voltage (Uc)	V	≡ 24	≈ 24	≈ 48	≡ 110...127	≈ 115...127	≈ 230...240	≈ 230...240
Current frequency	Hz	–	50/60	50/60	–	50/60	50/60	50/60
Energization threshold (at ± 5 %)	V	15	16.5	34	75	86	170	164
Maximum operating voltage	≡ / ≈	V 30	30	53	140	140	264	264
Maximum drop-out (at ± 5 %) voltage (Uo)	≡ / ≈	V 3.2	3.8	8.5	16	34	68	78
Maximum current (Un)	≡ / ≈	mA 62	62/55	36/32	15	8	7	5.5
Minimum holding current	≡ / ≈	mA 6.6	4.9/5.2	4.7/5.4	1.5	2.4	2	1.5
Maximum dissipated power	50 Hz/60 Hz	W 1.5	1.5	1.5	1.5	1.5	1.5	1.5
Disappearance of voltage maximum time up to which contact is maintained	ms	3	8	10	10	6	5	6
Display of control circuit by LED		No	Yes	Yes	Yes	Yes	Yes	No
Built-in protection reversed polarity		Yes	Yes	Yes	Yes	–	–	–

Contact characteristics

Type of interface		ABR 1E0000	ABR 1S0000
Maximum switching voltage	≈ V	252	252
	≡ V	125	125
Maximum rated operating voltage Ue	≈ V	230	230
	≡ V	125	125
Operating current frequency	Hz	50/60	50/60
Thermal current Ith	A	2	12
Rated operating current (Ie)	A	2	4
per 1 million operating cycles	AC12	1	1
	AC13	1	1
	AC14	1	1
	AC15	1	1
	DC12	2	5
	DC13	1	1
Minimum switching capacity	mA	3	3
Minimum switching voltage	V	17	17
Protection against short-circuits	A	gG/gF : 16	gG/gF : 16
Low power switching reliability of contacts (17 V - 5 mA)		10 ⁻⁸	10 ⁻⁸

Other characteristics

Operating time at Un and at 20 °C	Between energization of coil and closing of N/O contact	ms	≤ 12
	Between energization of coil and opening of N/C contact	ms	≤ 12
	Between de-energization of coil and opening of N/O contact	ms	≤ 12
	Between de-energization of coil and closing of N/C contact	ms	≤ 12
Duration of bounce		ms	≤ 3
Contact bridging times between contact "N/C" and "N/O"	Maximum make before break or break before make time	ms	1
Maximum operating rate	At no-load	Hz	6
	At Ie	Hz	0.5
Mechanical durability in millions of operating cycles	ABR-1 (1 N/O or 2 N/O)		≥ 20 million
	ABR-1 (1 C/O or 1 N/C + 1 N/O)		≥ 10 million
Rated isolation voltage	Conforming to IEC 947-1	V	250
	Conforming to VDE 0110 group C	V	250
Insulation test voltage for 1 min.	Between coil circuit and contact circuits	kV	4
	Between wired interface and earth	kV	2.5
	Between independent contacts	kV	1.5

Electrical durability of contacts

Test conditions : in accordance with standard IEC 947-5-1 set up for rated control voltage, operating rate : 1800 cycles/hour. (0.5 Hz).

a.c. loads

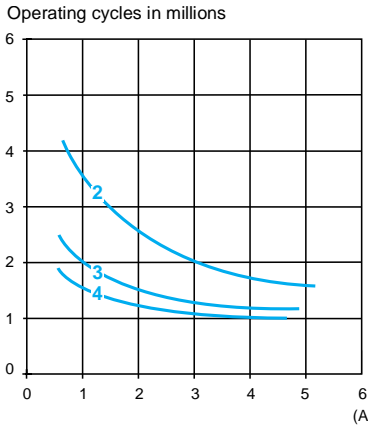

AC-12 : control of resistive loads and isolated solid state loads via optocoupler
 $\cos \varphi \geq 0.9$

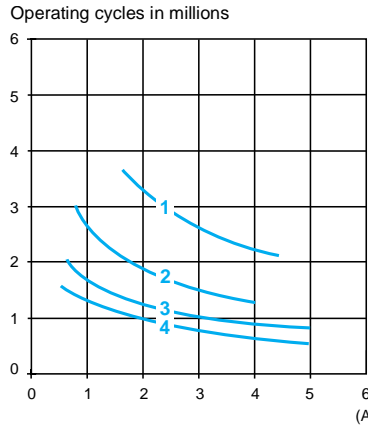

AC-13 : control of isolated solid state loads via transformer
 $\cos \varphi \geq 0.65$

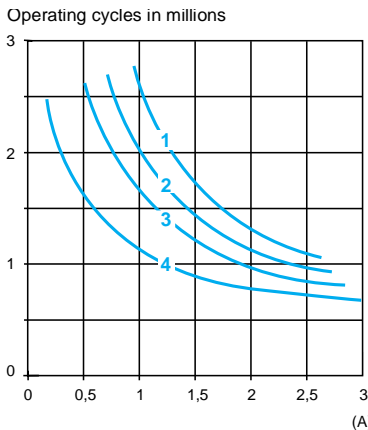

AC-14 : control of weak electromagnetic loads of electromagnets ≤ 72 VA
make: $\cos \varphi = 0.3$
break: $\cos \varphi = 0.3$
AC-15 : control of electromagnetic loads of electromagnets > 72 VA
make: $\cos \varphi = 0.7$
break: $\cos \varphi = 0.4$

- 1 24 V
- 2 48 V
- 3 127 V
- 4 230 V

d.c. loads

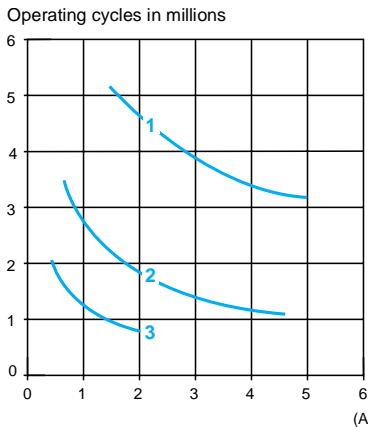

DC-12 : control of resistive loads and isolated solid state loads via optocoupler
 $L/R \leq 1$ ms

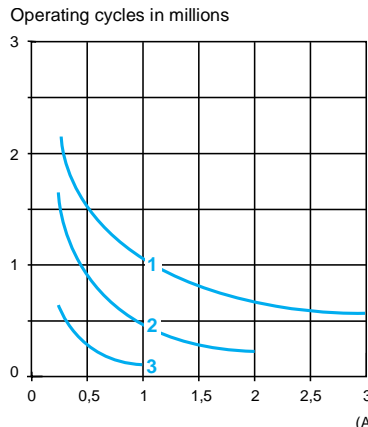

DC-13 : control of electromagnets
 $L/R \leq 2 \times (U_e \times I_e)$ in ms.
 U_e : rated operating voltage
 I_e : rated operating current

- 1 24 V
- 2 48 V
- 3 127 V

Interfaces

For discrete signals
Electromechanical interface modules
Control circuit : a.c. or d.c.

3



ABR 1E101M



ABR 1E318B



ABR 1S102B

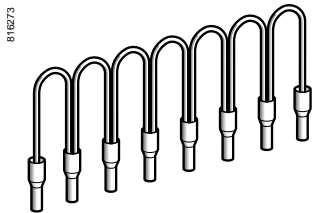

ABF C08R

Input interface modules (1) (17.5 mm pitch)

Display	Composition	Control circuit	Enclosure colour	Reference	Weight
					kg
V					
Mechanical (2)	1 N/O	~ 230/240	Grey	ABR 1E101M	0.090
	1 C/O	~ 230/240	Grey	ABR 1E301M	0.090
Mechanical (2) + LED (3)	1 N/O	~ 24	Grey	ABR 1E118B	0.095
		~ 48	Grey	ABR 1E118E	0.095
		--- 110...127 (4)	Grey	ABR 1E112F	0.095
		~ 115...127	Grey	ABR 1E111F	0.095
	2 N/O	~ 230/240	Grey	ABR 1E111M	0.095
		~ 24	Grey	ABR 1E418B	0.095
		~ 48	Grey	ABR 1E418E	0.095
		--- 110...127(4)	Grey	ABR 1E412F	0.095
		~ 115...127	Grey	ABR 1E411F	0.095
	1 C/O	~ 230/240	Grey	ABR 1E411M	0.095
		~ 24	Grey	ABR 1E318B	0.095
		~ 48	Grey	ABR 1E318E	0.095
		--- 110...127(4)	Grey	ABR 1E312F	0.095
	~ 115...127	Grey	ABR 1E311F	0.095	
	~ 230/240	Grey	ABR 1E311M	0.095	

Output terminals-relays (1) (17.5 mm pitch)

Display	Composition	Control circuit	Enclosure colour	Reference	Weight
					kg
V					
Mechanical (2)	1 N/O	--- 24	Grey	ABR 1S102B	0.090
	2 N/O	--- 24	Grey	ABR 1S402B	0.090
	1 C/O	--- 24	Grey	ABR 1S302B	0.090
	1 N/C + 1 N/O	--- 24	Grey	ABR 1S602B	0.090
Mechanical (2) + LED (3)	1 N/O	~ 24	Grey	ABR 1S118B	0.095
		~ 48	Grey	ABR 1S118E	0.095
		~ 115...127	Grey	ABR 1S111F	0.095
	2 N/O	~ 24	Grey	ABR 1S418B	0.095
		~ 48	Grey	ABR 1S418E	0.095
		~ 110	Grey	ABR 1S411F	0.095
		~ 110	Grey	ABR 1S311F	0.095
	1 C/O	~ 24	Grey	ABR 1S318B	0.095
		~ 48	Grey	ABR 1S318E	0.095
		~ 110	Grey	ABR 1S311F	0.095
	1 N/C + 1 N/O	~ 24	Grey	ABR 1S618B	0.095
		~ 48	Grey	ABR 1S618E	0.095
		~ 110	Grey	ABR 1S611F	0.095

Commoning links

Description	For common	Colour	Distance between cable ends	Reference	Weight
					kg
Commoning links in modules 8 x 1 mm²	Coil	White	12	ABF C08R12W	0.020
			2	ABF C08R02W	0.010
	~	Red	12	ABF C08R12R	0.020
			2	ABF C08R02R	0.010
	---	Blue	12	ABF C08R12B	0.020
			2	ABF C08R02B	0.010

(1) Connection by screw-clamp.

(2) By green mechanical indicator light for contact(s) activated electrically or mechanically by pressing the test button.

(3) By green LED illuminated when control signal is present.

(4) With polarization (+ on A1, - on A2).

Dimensions

ABR 1E

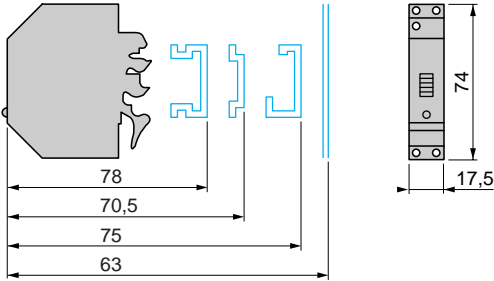

ABR 1S

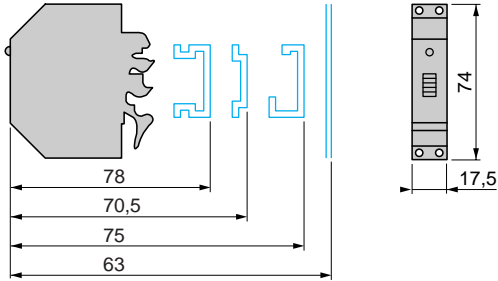

Schemes

— 24 V or ~ 230 V interfaces with mechanical indication

1 N/O

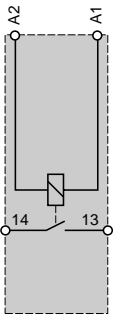

1 C/O

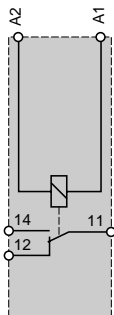

2 N/O

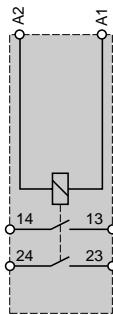

1 N/C + 1 N/O

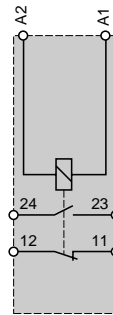

⋈ 24 V or ⋈ 48 V interfaces with mechanical indication + LED

1 N/O

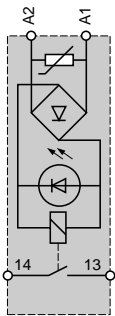

1 C/O

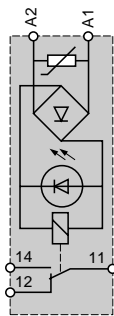

2 N/O

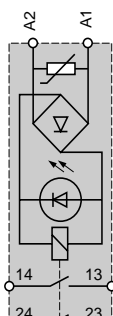

1 N/C + 1 N/O

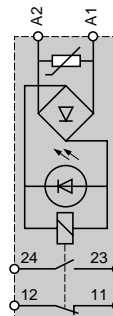

— / ~ 110 V or ~ 230 V interfaces with mechanical indication + LED

1 N/O

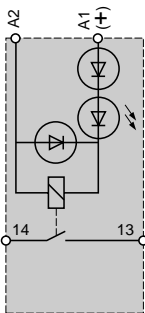

1 C/O

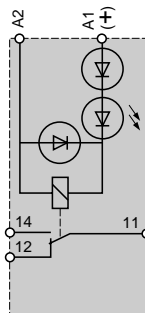

2 N/O

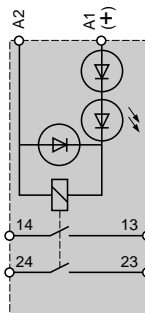

1 N/C + 1 N/O

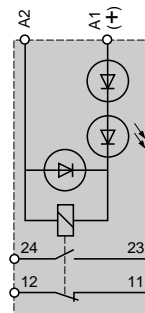

Interfaces

For discrete signals
Slim electromechanical interface modules

3

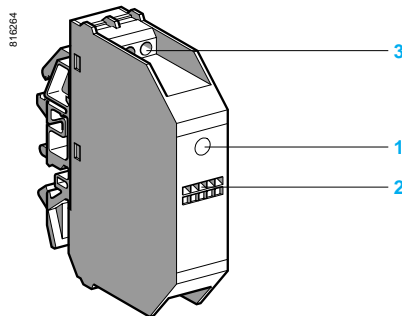
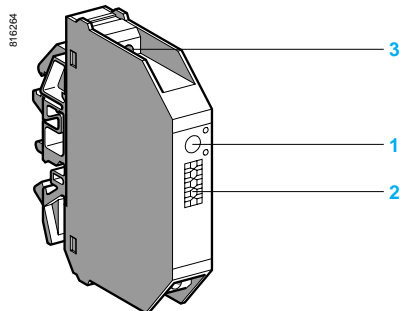
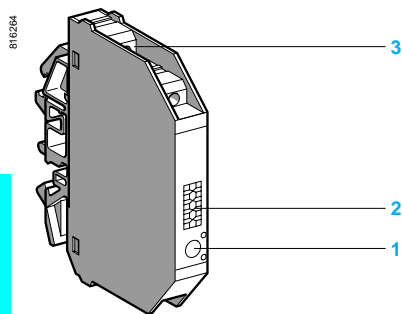

ABR-2 electromechanical interface modules complement the ABR-1 range. They are characterised by micro relay technology which allows reduced dimensions and very low switching levels (TTL, HCMOS, analogue signals). The ABR-2 family is in the form of slim compact modules, 9.5 mm wide for input interface modules, 12 mm wide for output interface modules and 17.5 mm wide for very low level switching products.

Description

The ABR-2 comprises 3 families :

Input interfaces (9.5 mm pitch)

Input interfaces are designed for switching input signals to a processor and are characterized by their high degree of contact reliability : less than 1 fault per 100 million operating cycles at $\pm 17\text{ V}$, 5 mA. An assured immunity to current leakages $\leq 2\text{ mA}$, and a wide coil voltage range (0.7 to 1.25 U_n).

Output interfaces (12 mm pitch)

Output interfaces are designed for the control of preactuators (contactors, solenoid valves, etc) for signalling devices (indicators lamps, audible warnings etc). They are characterized by a high switching capacity and an assured immunity to current leakages $\leq 2\text{ mA}$. A lower cost version without LED signalling is available.

Low level switching input and output interfaces (17.5 mm pitch) with 1 C/O contact.

These interfaces are designed for switching logic (TTL or HCMOS) and analogue signals.

Warning : never switch inductive loads with this type of interface.

The front panel of the ABR-2 electromechanical interface module comprises :

- 1 LED indicating the control signal state
- 2 Channel identification : 5 individual characters for AB1-R/G or 1 AB1-SA2 marker tag
- 3 Connection by screw clamp terminal enabling easy attachment of 2 wires per terminal. The layout of the connection terminals for both families (input and output) is designed for rational wiring and a clear separation between the incoming (processing) and outgoing (power and process control) circuits.

Examples of applications with PLCs

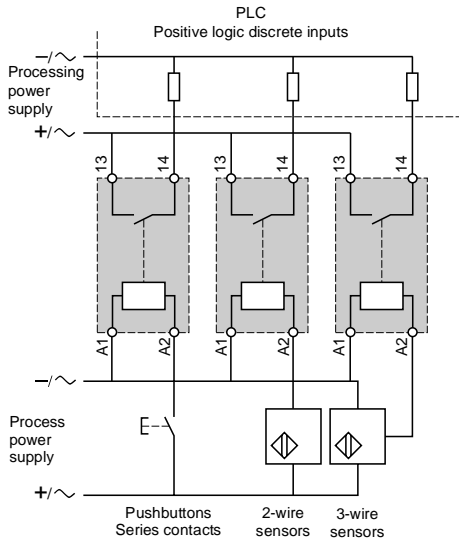

ABR 2E●●●●

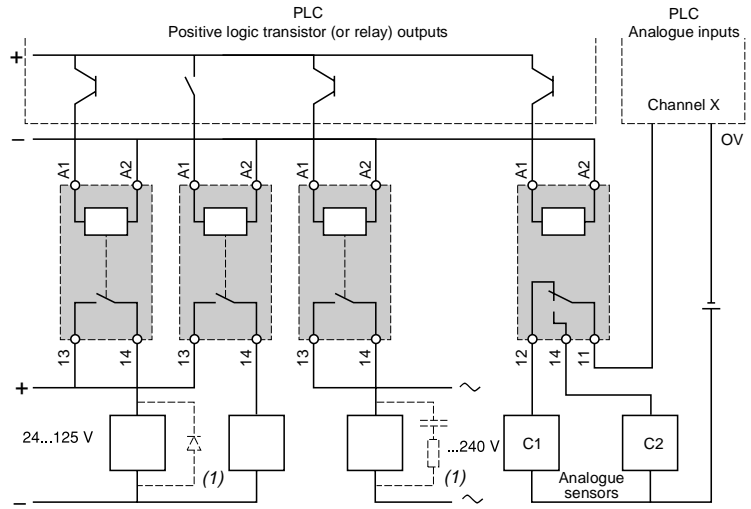

ABR 2S●●●●

ABR 2SB12B

(1) Essential on inductive loads (can be replaced with peak limiter).

Environment

Conforming to standards		IEC 947-5-1		
Product certifications		UL, CSA, BV, LROS, DNV		
Degree of protection	Conforming to IEC 529 (protection against direct contact)	IP 20		
Protective treatment		"TC"		
Flame resistance	Conforming to IEC 695-2-1	Incandescent wire	°C 960	
		Conforming to UL 94	V0	
Shock resistance	Conforming to IEC 68-2-27	Semi-sinusoidal waves 11 ms	30 gn	
Vibration resistance	Conforming to IEC 68-2-6	10...150 Hz	3 gn	
Resistance to electrostatic discharges	Conforming to IEC 801-2	Level 3	kV 8	
Resistance to electromagnetic fields	Conforming to IEC 801-3	Level 3 ; 27...1000 MHz	V/m 10	
Resistance to rapid transients	Conforming to IEC 801-4 Level 3	On power supply	kV 2	
		On I/O	kV 1	
Resistance to shock waves	Conforming to IEC 947-1	Waveform 1.2/50 μs ; 0.5 J	U < 50 V	kV 0.5
			U < 150 V	kV 1.5
			U < 300 V	kV 2.5
Cross-sections which may be connected	Flexible cable with no cable end	1 or 2-wire	mm ² 0.6...2.5	
	Flexible cable with cable end	1 or 2-wire	mm ² 0.34...2.5	
	Rigid cable	1-wire	mm ² 0.27...4	
Operating position		Any		
Ambient air temperature	Unrestricted operation	°C	- 5...+ 40	
	Operation from 0.85...1.1 Us (assigned voltage)	°C	- 5...+ 55	
	Operation restricted to Us (assigned voltage)	°C	- 25...+ 70 (2)	
	Storage	°C	- 40...+ 80	
Operating altitude		m	≤ 3000	
Installation category		Conforming to IEC 947-1 II		
Degree of pollution		Conforming to IEC 947-1 2		
Mounting		Standard rails		

(2) Leave space of 8 mm between ABR-2S1●●● for an ambient temperature ≥ 55 °C

3

Control circuit characteristics (40°C ambient temperature)										
Type of interface		ABR 2E112B	ABR 2E112E	ABR 2E115F	ABR 2E116F	ABR 2E111M	ABR 2S112B	ABR 2S102B	ABR 2●B312B (1)	
Rated voltage (Us)	V	--- 24	--- 48	~ 115...127	~ 120...127	~ 230...240	--- 24	--- 24	--- 24	
Current frequency	Hz	–	–	50	60	50/60	–	–	–	
Energization threshold	V	16.9	37.3	93	97	186	16.9	14.5	16.9	
Maximum operating voltage	V	28.8	57.6	140	140	264	28.8	28.8	28.8	
Maximum drop-out voltage (Uo)	V	3.8	8.5	25.4	25.4	48	3.8	2	3.8	
Maximum current (at Us)	mA	19.5	11	14	16	15	28	18	23	
Minimum holding current	mA	2	2	2.5	2.5	2.5	2	1.3	2	
Maximum dissipated power (at Us)	50 Hz	W	–	0.66	–	0.54	–	–	–	
	60 Hz	W	0.45	0.52	–	0.73	0.64	0.43	0.55	
Disappearance of voltage maximum time up to which contact is maintained	ms	1	1	10	10	10	1	5	1	
Display of control circuit by LED		Yes	Yes	Yes	Yes	Yes	Yes	Yes	Yes	
Built-in protection reversed polarity		Yes	Yes	–	–	–	Yes	Yes	Yes	
Contact characteristics (40°C ambient temperature)										
Type of interface		ABR 2E●●●●		ABR 2S112B		ABR 2S102B		ABR 2●B312B (1)		
Composition		1 N/O		1 N/O		1 N/O		1 C/O		
Maximum rated operating voltage (Ue max)	~ V	127		230		230		48		
	--- V	100		120		120		48		
Maximum switching voltage	~ V	140		250		250		60		
	--- V	125		150		150		60		
Operating current frequency	Hz	50/60		50/60		50/60		50/60		
Thermal current Ith	A	1		5		5		0.05		
Rated operating current (Ie) for 1 million operating cycles	Conforming to IEC 947-5-1	AC12	A	1	3	3	–	–	–	
		AC14	A	0.5	1	1	–	–	–	
		AC15	A	0.5	1	1	–	–	–	
	Conforming to IEC 947-5-1 Ue : --- 24 V	DC12	A	1	1.7	1.7	–	–	–	
		DC13	A	1	1.5	1.5	–	–	–	
Minimum switching current	mA	1		5		5		0.01		
Minimum switching voltage	V	5		5		5		0.01		
Protection against short-circuits	For I _k ≤ 1 kA (~) and ≤ 100 A (---) Type and value of recommended fuse	A	Type : quick-blow fuse with high breaking capacity		2		6.3		0.4	
Low level contact reliability (17 V, 5 mA)/ ABR-2pB (30 mV, 10 µA)	Number of faults per "n" million operating cycles		1 per 100 million							
Other characteristics										
Maximum operating time at Us (bounce included)	Between energization of coil and closing of N/O contact	---	ms	10	10	10	6	–	–	
	Between energization of coil and opening of N/C contact	~	ms	30	–	–	–	6	–	
	Between de-energization of coil and opening of N/O contact	---	ms	6	12	5	6	–	–	
	Between de-energization of coil and closing of N/C contact	~	ms	30	–	–	–	6	–	
	Maximum duration of bounce		ms	5	5	5	2	–	–	
No make before break guaranteed between "N/C" and "N/O" contacts	Maximum make On energization		ms	–	–	–	5	–	–	
	before break or break On de-energization		ms	–	–	–	2	–	–	
Maximum operating rate	At no-load	Hz	10	10	10	10	–	–	–	
	At Ie	Hz	0.5	0.5	0.5	–	–	–	–	
Mechanical durability in millions of operating cycles			20	10	10	20	–	–	–	
Rated insulation voltage	Conforming to IEC 947-1	V	300	300	300	300	–	–	–	
	Conforming to VDE 0110 group C	V	250	250	250	250	–	–	–	
Insulation test voltage for 1 min	Coil circuit/contact circuits	kV rms	2	4	4	1.5	–	–	–	
	Wired interface/earth	kV rms	2.5	2.5	2.5	2.5	–	–	–	
	Between open contacts	kV rms	0.75	1	1	1	–	–	–	

(1) Do not switch inductive loads.

Electrical durability of contacts (ABR 2S)

Test conditions : in accordance with standard IEC 947-5-1 set up for rated control voltage.

a.c. loads

Operating cycles in millions

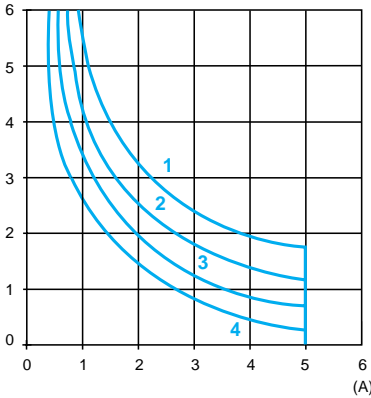

AC12 : control of resistive loads and isolated solid state loads via optocoupler
 $\cos \varphi \geq 0.9$

Operating cycles in millions

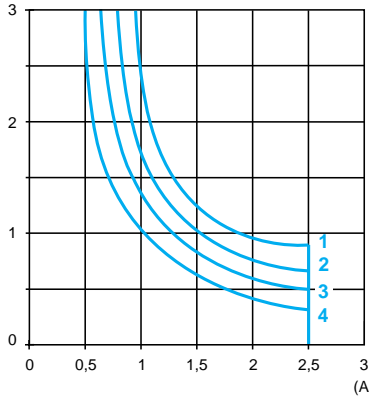

AC14 : control of weak electro-magnetic loads of electro-magnets $\leq 72 \text{ VA}$

make : $\cos \varphi = 0.3$

break : $\cos \varphi = 0.3$

AC15 : control of electro-magnetic loads of electro-magnets $> 72 \text{ VA}$

make : $\cos \varphi = 0.7$

break : $\cos \varphi = 0.4$

- 1 24 V
- 2 48 V
- 3 115 V
- 4 230 V



d.c. loads

Operating cycles in millions

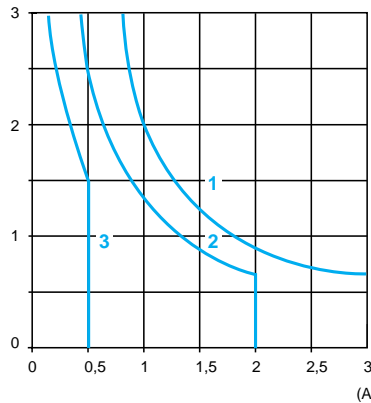

DC12 : control of resistive loads and isolated solid state loads via optocoupler
 $L/R \leq 1 \text{ ms}$

Operating cycles in millions

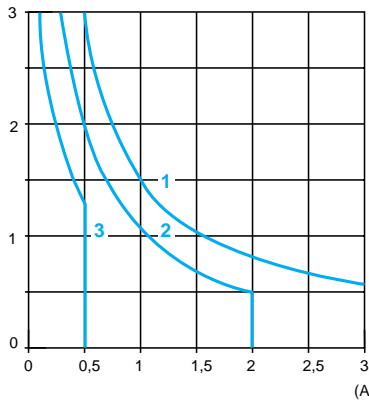

DC13 : control of electro-magnets

$L/R \leq 2 \times (U_e \times I_e)$ in ms.

U_e : rated operating voltage

I_e : rated operating current

(with a load protection diode)

- 1 24 V
- 2 48 V
- 3 115 V

Interfaces

For discrete signals

Slim electromechanical interface modules

Control circuit : a.c. or d.c.

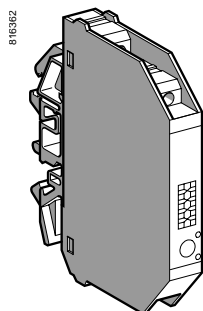

ABR 2E112B

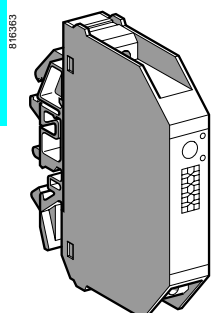

ABR 2S112B

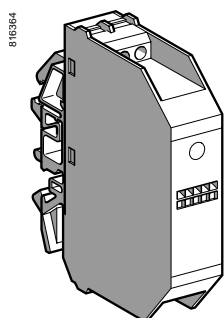

ABR 2EB112B

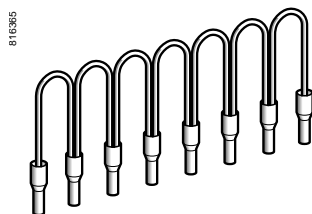

ABR C08R000

Input modules (9.5 mm pitch)

Indication	Composition	Control circuit	Sold in lots of	Unit reference	Weight
		V			kg
With LED	1 N/C	≡ 24	5	ABR 2E112B	0.032
		≡ 48	5	ABR 2E112E	0.032
		~ 115...127 (50 Hz)	5	ABR 2E115F	0.035
		~ 120...127 (60 Hz)	5	ABR 2E116F	0.035
		~ 230...240 (50/60 Hz)	5	ABR 2E111M	0.036

Output modules (12 mm pitch)

Indication	Composition	Control circuit	Sold in lots of	Unit reference	Weight
		V			kg
Without	1 N/C	≡ 24	5	ABR 2S102B	0.040
With LED	1 N/C	≡ 24	5	ABR 2S112B	0.041

Modules for very low level switching (17.5 mm pitch)

Indication	Composition	Control circuit	Reference	Weight
		V		kg
Input				
With LED	1 C/O (1)	≡ 24	ABR 2EB312B	0.048
Output				
With LED	1 C/O (1)	≡ 24	ABR 2EB312B	0.048

Flexible comb accessories

Description	For common	Colour	Distance between cable ends	Reference	Weight
Flexible comb modularity 8 x 1 mm ²	Coil	White	12	ABF C08R12W	0.020
			2	ABF C08R02W	0.010
	~	Red	12	ABF C08R12R	0.020
			2	ABF C08R02R	0.010
	≡	Blue	12	ABF C08R12B	0.020
			2	ABF C08R02B	0.010

(1) Do not switch inductive loads.

Dimensions

ABR 2E11●●

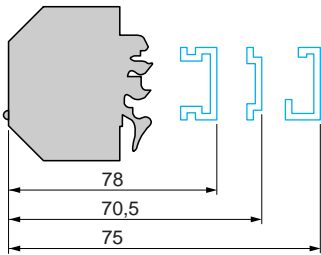

ABR 2S1●2B

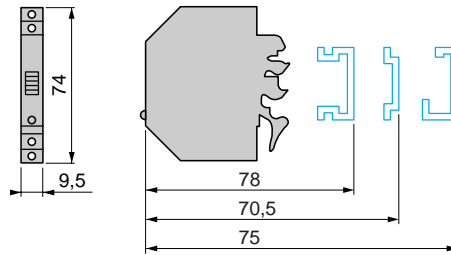

ABR 2EB312B

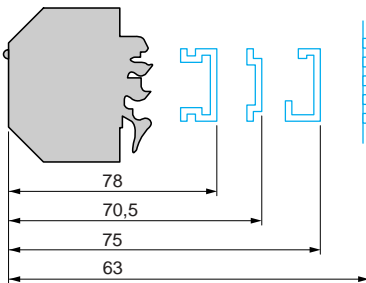

ABR 2SB312B

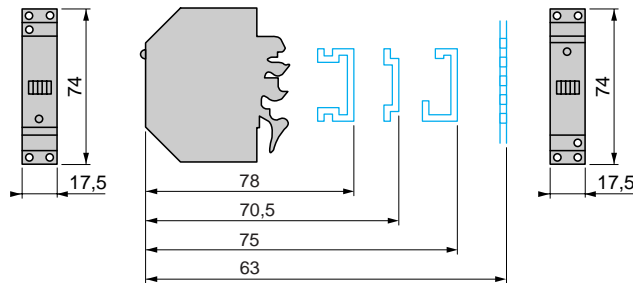

Circuit diagrams

ABR 2E112B (≐ 24 V)

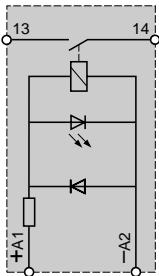

ABR 2E112E (≐ 48 V)

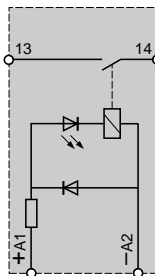

ABR 2E11●F/M (∼ 115...240 V)

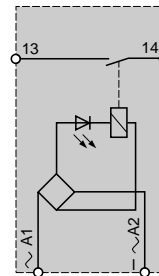

ABR 2S102B (≐ 24 V)

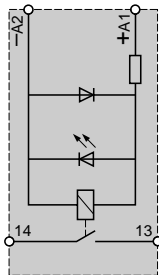

ABR 2S112B (≐ 24 V)

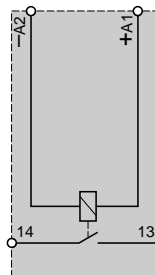

ABR 2●B312B (≐ 24 V)

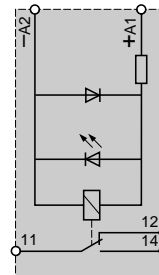

Interfaces

For discrete signals
Slim solid-state interface modules

3

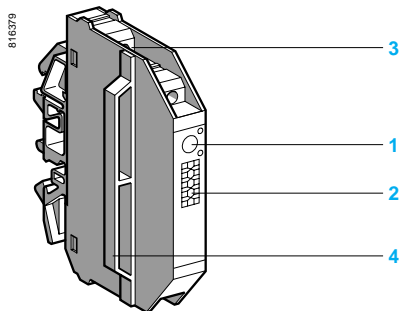
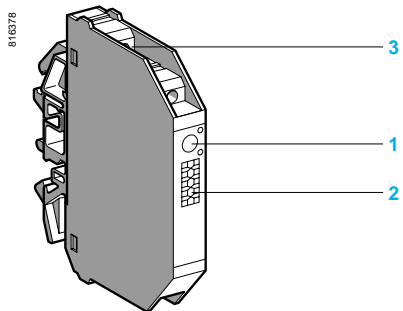
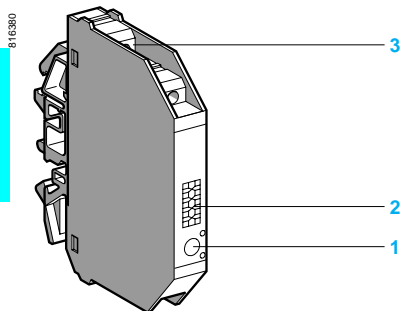

The ABS-2 solid-state interface relays are supplied in the form of compact modules which appear identical to the ABR-2 electromechanical family. They are designed for interfacing discrete digital control signals exchanged within an automated system between the processor (PLC, numerical controller, etc) and the other components (contactors, solenoid valves, indicator lamps, proximity sensors, etc).

They are suitable for use in equipment which requires the benefits of electronic technology : a high operating rate, virtually unlimited durability, silent operation, etc. These products are notable for their high performance and excellent adaptation to industrial environments, ensured by the fact that they conform to the most recent IEC standards.

Composition

The ABS-2 range comprises 2 families :

Input interfaces

The 9.5 mm wide input interfaces are designed for switching input signals to processors. They offer a wide choice of electrical isolation between signals due to the wide range of input voltages from ≈ 5 V to ~ 230 V.

Output interfaces

Output interfaces are designed for the control of preactuators (contactors, solenoid valves, etc) for the signalling devices (indicator lamps, audible warnings, etc). Two widths are available, 9.5 and 17.5 mm, depending on the switched current.

The 17.5 mm version comprises a 9.5 mm interface and an integrated 8 mm spacer. This device can, with its increased ventilation, switch high levels of currents.

- The front panel of the ABS-2 slim solid-state interface modules comprises:
- 1 LED indicating the state of the control signal.
 - 2 Channel identification : 5 individual characters for AB1-/G or one AB1-SA2 marker tag.
 - 3 Connection by screw clamp terminal enabling easy attachment of 2 wires per terminal.
 - 4 Integrated spacer.
- The layout of the connection terminals for both families (input and output) is designed for rational wiring and a clear separation between the incoming (processing) and outgoing (power and process control) circuits.

Examples of applications with PLCs

Interfacing PLC discrete inputs

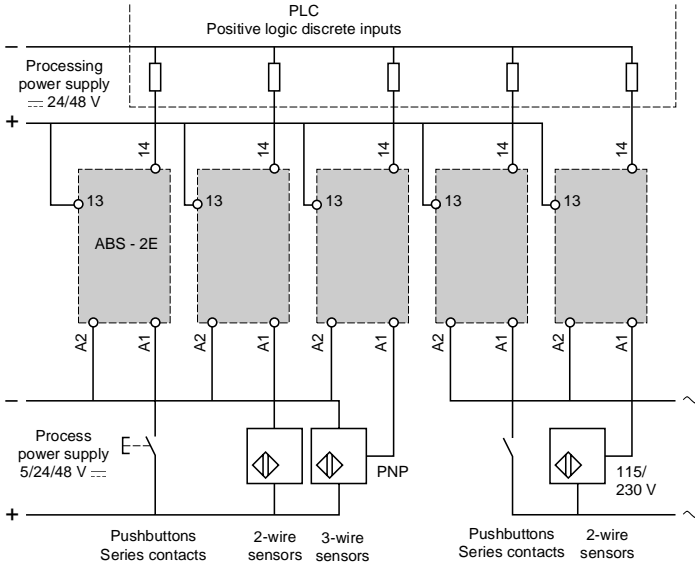

Interfacing PLC discrete outputs

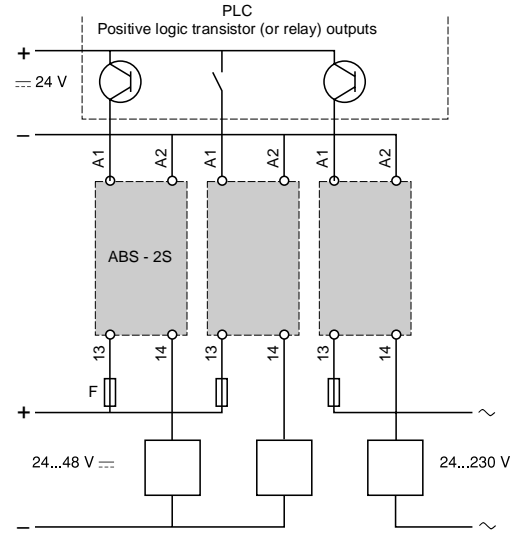

3

Environment

Conforming to standards		IEC 947-5-1 Draft standard IEC 17 B secretariat 200		
Product certifications		UL, CSA, BV, LROS, DNV		
Degree of protection	Conforming to IEC 529 (protection against direct contact)	IP 20		
Protective treatment		"TC"		
Flame resistance	Conforming to IEC 695-2-1	Incandescent wire	°C 960	
		Conforming to UL 94	V0	
Shock resistance	Conforming to IEC 68-2-27	Semi-sinusoidal waves 11 ms	30 gn	
Vibration resistance	Conforming to IEC 68-2-6	10...150 Hz	5 gn	
Resistance to electrostatic discharges	Conforming to IEC 801-2	Level 3	kV 8	
Resistance to electromagnetic fields	Conforming to IEC 801-3	Level 3 ; 27...1000 MHz	V/m 10	
Resistance to rapid transients	Conforming to IEC 801-4 Level 3	On power supply	kV 2	
		On I/O	kV 1	
Resistance to shock waves	Conforming to IEC 947-1	Waveform 1.2/50 ms ; 0.5 J	U < 50 V	kV 0.5
			U < 150 V	kV 1.5
			U < 300 V	kV 2.5
Cross-sections which may be connected	Flexible cable with no cable end	1 or 2-wire	mm ² 0.6...2.5	
	Flexible cable with cable end	1 or 2-wire	mm ² 0.34...2.5	
	Rigid cable	1-wire	mm ² 0.27...4	
Operating position		Any		
Ambient air temperature around the device	Unrestricted operation	°C - 5...+ 55		
	Operation at Us	°C - 25...+ 70		
	Storage	°C - 40...+ 80		
Operating altitude		m ≤ 300		
Installation category	Conforming to IEC 947-1	II		
Degree of pollution	Conforming to IEC 947-1	2		
Mounting		Standard rails 15 25 35		

Interfaces

For discrete signals
Slim solid-state interface modules

3

Control circuit characteristics (55°C ambient temperature)									
Type of interface			ABS 2EC01EA	ABS 2EC01EB	ABS 2EC01EE	ABS 2EA01EF	ABS 2EA02EF	ABS 2EA01EM	ABS 2EA02EM
Rated voltage Us	≡	V	5	24	48	–	–	–	–
	~	V	–	–	–	115/127 50 Hz	120/127 60 Hz	230/240 50 Hz	230/240 60 Hz
Maximum voltage	≡	V	Negative logic 6 (TTL)	28.8	57.6	–	–	–	–
	~	V	–	–	–	140	140	264	264
Maximum current at Us	≡	mA	13.6	12	10.5	–	–	–	–
	~	mA	–	–	–	14	17	12.5	15
State 1 assured	≡	V	3.75	16.9	36	–	–	–	–
		mA	4.5	7.7	7.5	–	–	–	–
	~	V	–	–	–	86.3	90	173	173
State 0 assured	≡	V	2	5.6	10.8	–	–	–	–
		mA	0.09	2	2	–	–	–	–
	~	V	–	–	–	25.4	25.4	48	48
		mA	–	–	–	2.5	2.5	2.5	2.5
State 1 display			Yes	Yes	Yes	Yes	Yes	Yes	Yes
Internal protection reversed polarity			Yes	Yes	Yes	–	–	–	–
Output circuit characteristics									
Rated operating voltage Ue	≡	V	5...48						
Min/max voltage	≡	V	2/60						
Min/max current switched		mA	1/50						
Maximum residual current at state 0		mA	0.1						
Maximum volt drop at state 1		V	1						
Internal protection			Reversed polarity						
External protection			Against short-circuits for I _k ≤ 100 A (---) Quick-blow fuse, ref. : HA21 0.25 A or equivalent						
Other characteristics									
Type of interface			ABS 2EC01EA	ABS 2EC01EB	ABS 2EC01EE	ABS 2EA01EF	ABS 2EA02EF	ABS 2EA01EM	ABS 2EA02EM
Time delay characteristics	0 → 1	ms	0.05	0.05	0.05	10	10	10	10
	Response time max U _e ≤ 30 V I _e ≥ 5 mA	1 → 0	ms	0.4	0.4	0.4	20	20	20
Maximum switching rate		Hz	1000	1000	1000	25	25	25	25
Duty cycle 50 %									
U _e ≤ 30 V I _e ≥ 5 mA									
Rated insulation voltage			Conforming to IEC 947-1 : 300 V						
			Conforming to VDE 0110 : 250 V group C						
Insulation test voltage for 1 minute	I/O	kVrms	4						
	Wired interface/earth	kVrms	2.5						

Control circuit characteristics (55°C ambient temperature)

Type of interface		ABS 2SC01EB	ABS 2SC02EB	ABS 2SA01MB	ABS 2SA02MB
Rated voltage U_s	---	V	24	24	24
Maximum voltage		V	28.8	28.8	28.8
Maximum current at U_s		mA	12	13.6	13.6
State 1 assured		V	16.9	16.9	16.9
		mA	7.7	8.3	8.3
State 0 assured		V	5.6	5.3	5.3
		mA	2	2	2
State 1 display			Yes	Yes	Yes
Internal protection reversed polarity			Yes	Yes	Yes

Output circuit characteristics

Rated operating voltage U_e		V	--- 5...48	--- 5...48	~ 24...240	~ 24...240
Maximum voltage		V	--- 57.6	--- 57.6	~ 264	~ 264
Maximum continuous current (I _{th}) (1)		A	2	3	2.3	3
Rated operating voltage (I _e) Conforming to IEC 947-5-1 Single/touching product at 55 °C vertical position		A	DC12 1.5/0.9	2.5/2.2	AC12 1.9/0.5	2.1/1.5
		A	DC13 1.5/0.9	2.5/2.2	AC13 1.6/0.5	1.6/1.5
		A	DC14 0.6/0.6	0.6/0.6	AC14 1.6/0.5	1.6/1.5
		A	– –	–	AC15 1/0.5	1/1
Minimum current	---/~	mA	1	1	10	10
Maximum residual current	---/~	mA	1	1	2.5	2.5
Maximum volt drop		V	1.5	1.5	3 (I _e ≥ 10 mA) 1.5 (I _e ≥ 100 mA)	3 (I _e ≥ 10 mA) 1.5 (I _e ≥ 100 mA)
“0 crossing” voltage		V	–	–	50 peak	50 peak
Solid-state dV/dt		V/μs	–	–	500	500
Internal protection			Reversed polarity			
External protection			Against short-circuits for I _k ≤ 1 kA (~) and ≤ 100 A (---) Quick-blow fuse with high breaking capacity: 3.15 A			

Other characteristics

Maximum response time at I _e ≥ 10 mA	0 → 1	ms	0.05			10 (50 Hz) ; 8 (60Hz)	
	1 → 0	ms	0.6			10 (50 Hz) ; 8 (60Hz)	
Maximum switching rate At 55 °C ; at I _e : module alone duty cycle 40 %		Hz	DC13	6	6	AC13	0.6 0.7
		Hz	DC14	1	3	AC14	0.6 0.7
		Hz	–	–	–	AC15	0.6 0.7
		Hz	700			50	
Rated operating voltage			Conforming to IEC 947-1 : ~ 300 V				
			Conforming to VDE 0110 : 250 V group C				
Rated Insulation voltage for 1 minute	I/O	kVrms	4				
	Wired interface/earth	kVrms	2.5				

(1) See temperature derating curves.

Solid-state input modules

Width mm	Input circuit		Output circuit		Sold in lots of	Unit reference	Weight kg
	Current	Nominal voltage V	Current	Nominal voltage V			
9.5	—	5	—	5...48	5	ABS 2EC01EA	0.029
		24	—	5...48	5	ABS 2EC01EB	0.029
		48	—	5...48	5	ABS 2EC01EE	0.029
	~	115...127 (50 Hz)	—	5...48	5	ABS 2EA01EF	0.032
		120...127 (60 Hz)	—	5...48	5	ABS 2EA02EF	0.032
		230...240 (50 Hz)	—	5...48	5	ABS 2EA01EM	0.033
		230...240 (60 Hz)	—	5...48	5	ABS 2EA02EM	0.033

Solid-state output modules

Width mm	Input circuit		Output circuit		Sold in lots of	Unit reference	Weight kg
	Current	Nominal voltage V	Current A	Nominal voltage V			
9.5	—	24	— 2	24...48	5	ABS 2SC01EB	0.034
			~ 2.3	24...230	5	ABS 2SA01MB	0.034
17.5	—	24	— 3	24...48	1	ABS 2SC02EB	0.043
			~ 3	24...230	1	ABS 2SA02MB	0.044

Accessories

For connecting commons, use **ABF C08●●●** flexible combs (see page 4/43)

Temperature derating curve for solid-state output modules $U_c = U_s = \text{—} 24 \text{ V}$

ABS 2SC01EB d.c.

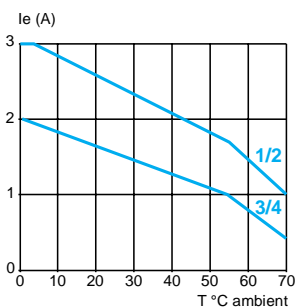

ABS 2SC02EB d.c.

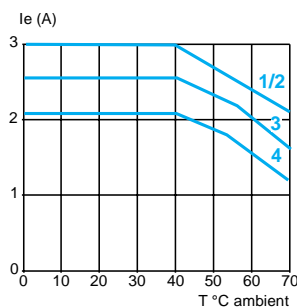

ABS 2SA01MB a.c.

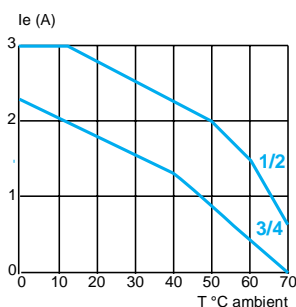

ABS 2SA02MB a.c.

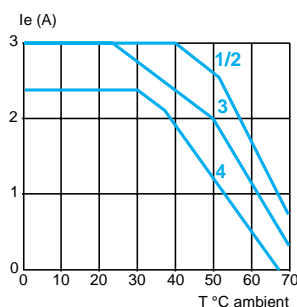

1 Vertical module alone or adjacent to modules with low heat dissipation.

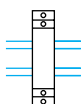

2 Horizontal module alone or adjacent to modules with low heat dissipation.

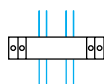

3 Vertical module mounted with 2 modules with identical heat dissipation on both sides.

4 Horizontal module mounted with 2 modules with identical heat dissipation on both sides.

Dimensions

ABS 2E/ABS 2S0100

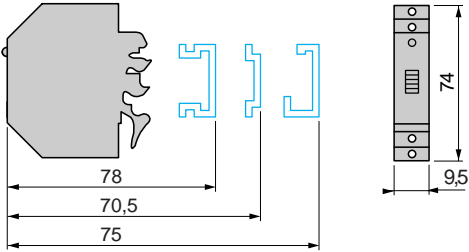

ABS 2S0200

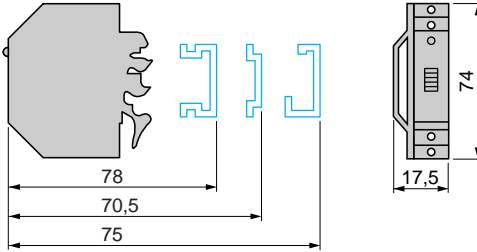

Circuit diagrams

Solid-state input modules

ABS 2EC000

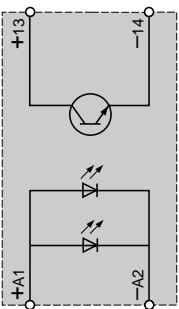

ABS 2EA000

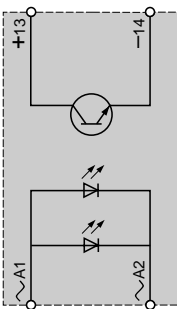

ABS 2E000

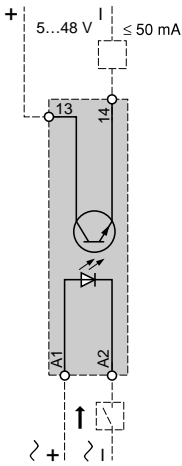

Solid-state output modules

ABS 2SC00EB

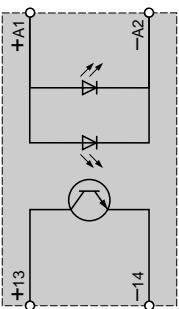

ABS 2SA00MB

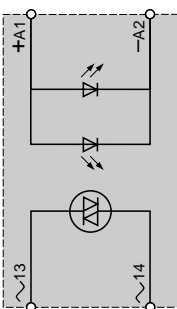

ABS 2SC00EB

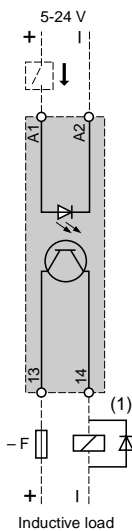
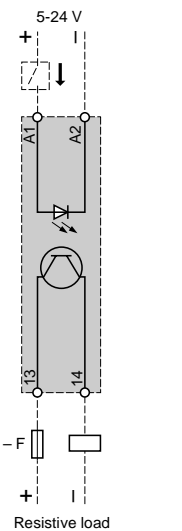

ABS 2SA00MB

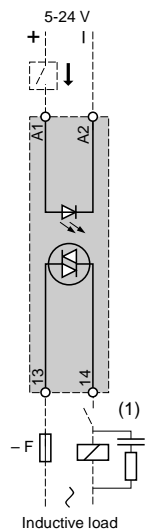
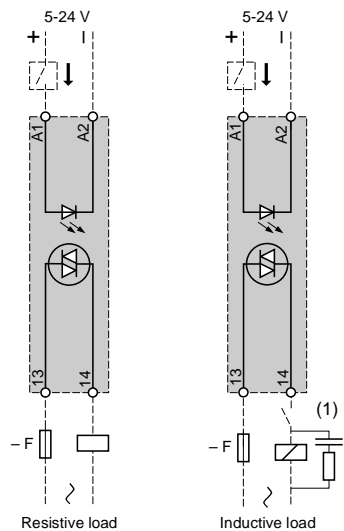

F: fuse DF1 SS133.2
(1) or peak limiter